

* = EXCL PASCAL RAMEN EN DEUREN

Peil= bovenkant afgewerkte vloer

Betreft : AT 86 ST

Getekend : WK

Onderwerp : Deur met isostonedorpel

Datum : 28-07-2019

Onderdeel : Profielen

Schaal : 1:2

Vuurijzer 9

5753 SV Deurne

Tel: 0493 31 77 81



ADbi 0

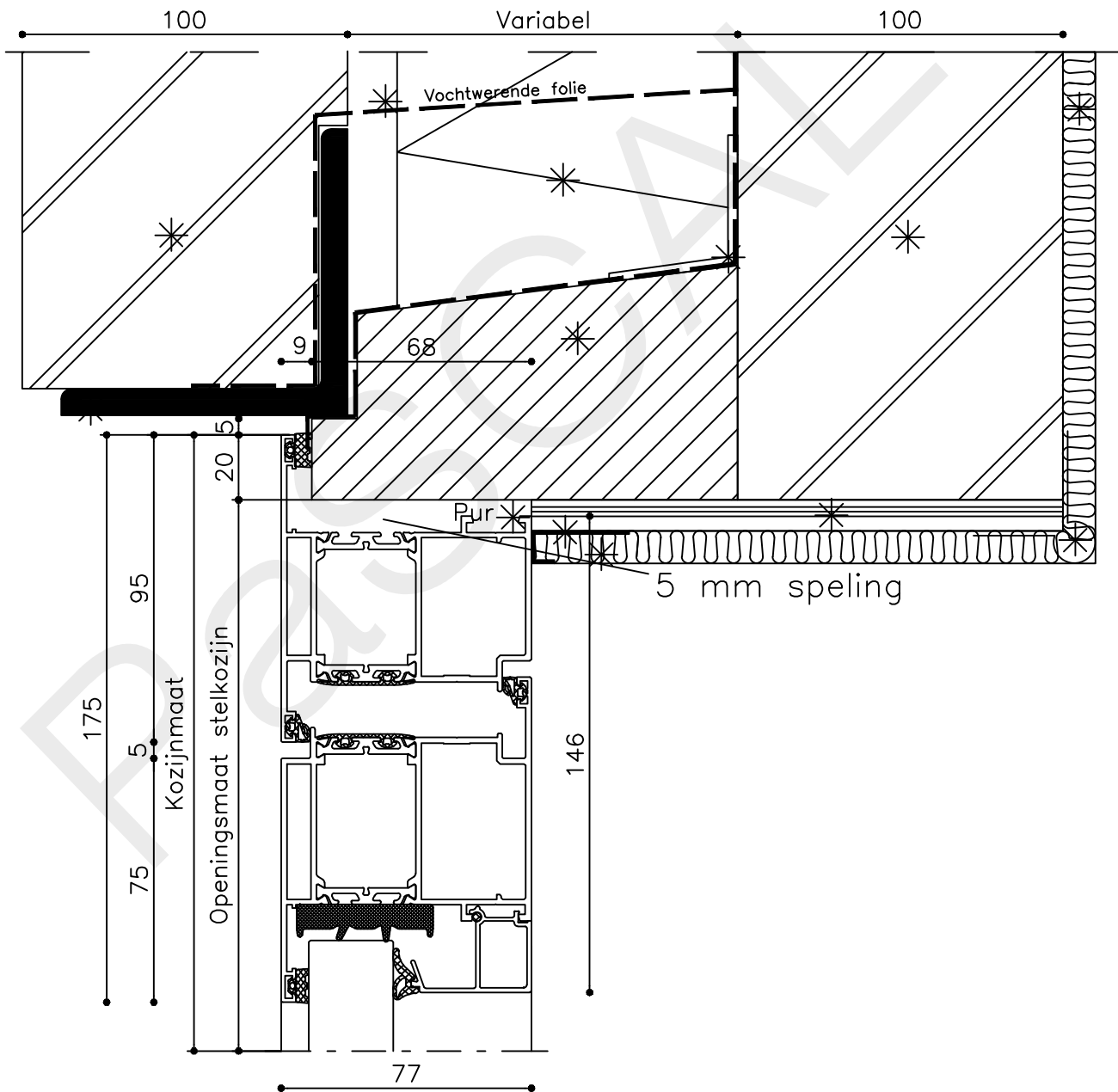
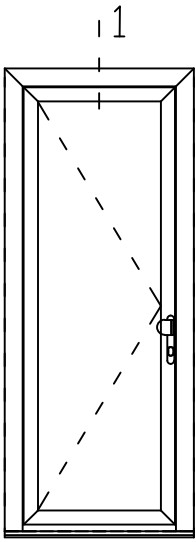

* = EXCL PASCAL RAMEN EN DEUREN

	Peil= bovenkant afgewerkte vloer	Betreft : AT 86 ST Onderwerp : Deur bi Onderdeel : Bovendetail	Getekend : WK Datum : 28-07-2023 Schaal : 1:2
	Vuurijzer 9 5753 SV Deurne Tel: 0493 31 77 81	ADbi 1	

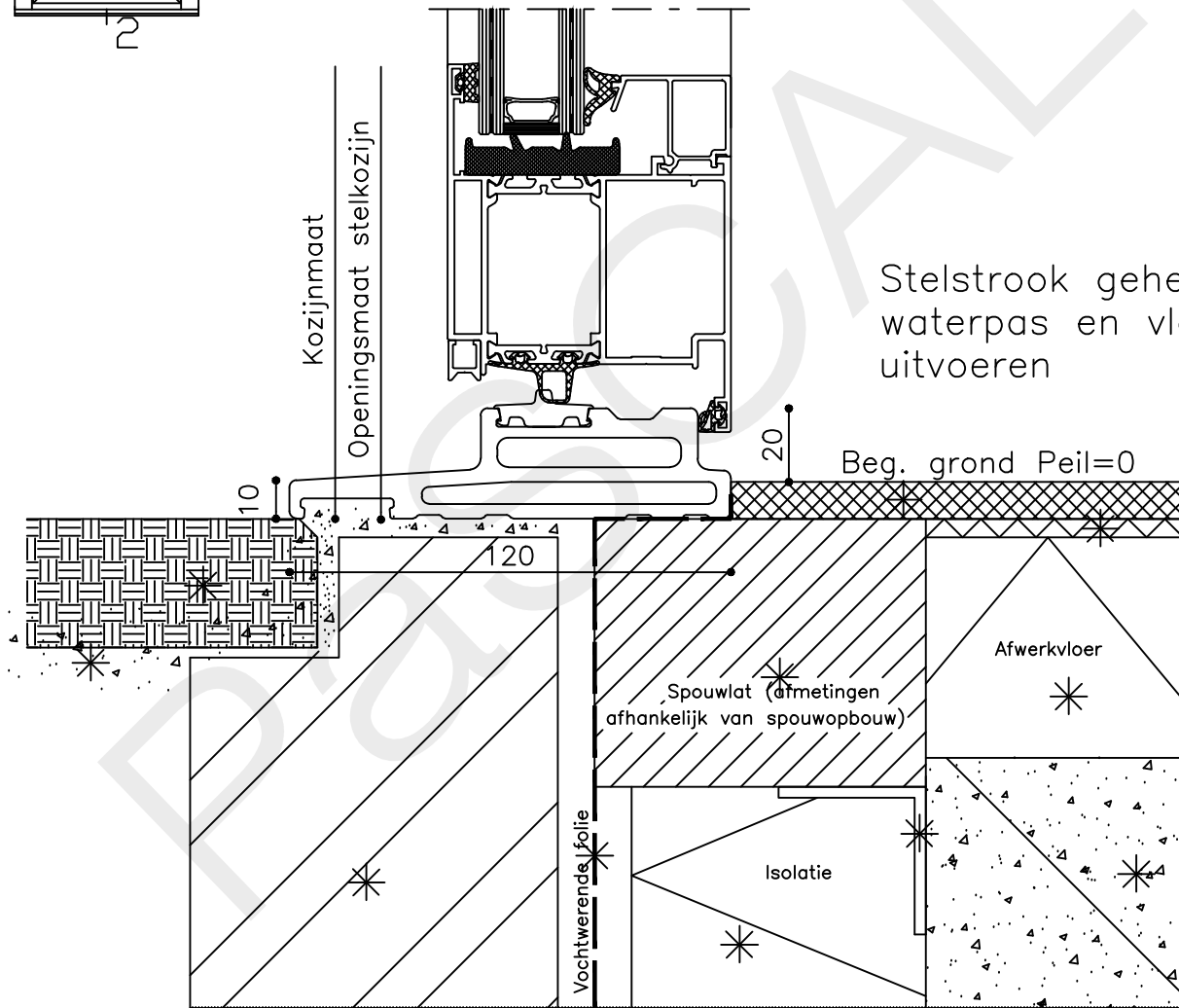
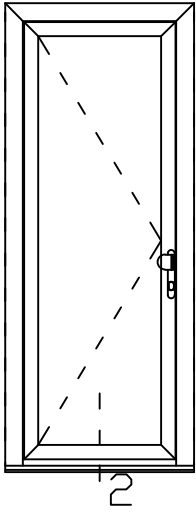

* = EXCL PASCAL RAMEN EN DEUREN

	Peil= bovenkant afgewerkte vloer	Betreft : AT 86 ST	Getekend : WK
		Onderwerp : Deur met isostonedorpel	Datum : 28-07-2023
		Onderdeel : Onderdetail	Schaal : 1:2
		Vuurijzer 9 5753 SV Deurne Tel: 0493 31 77 81	ADbi 2

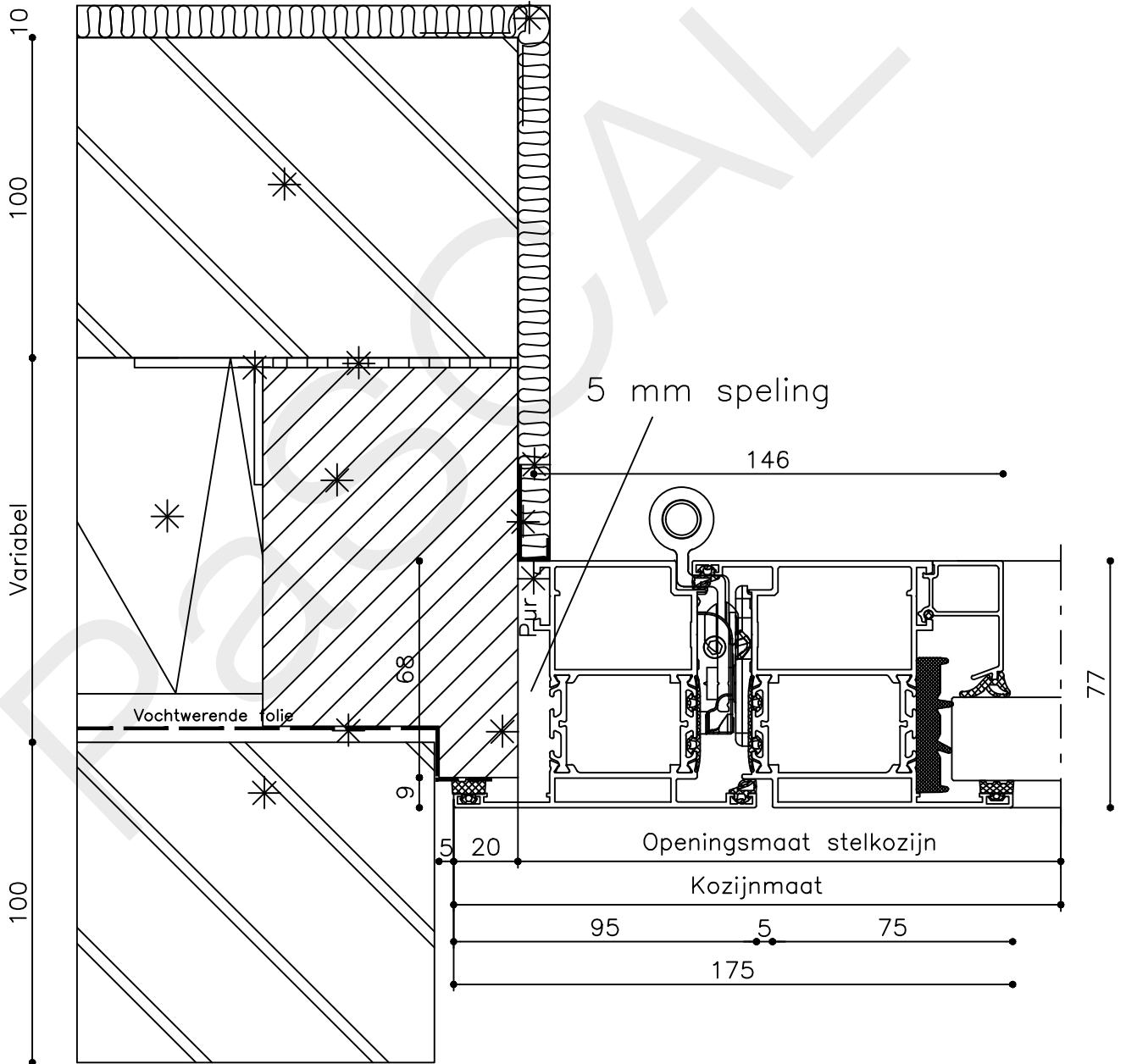
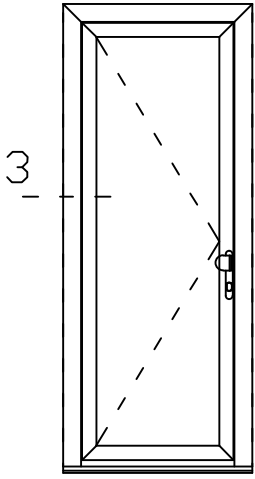

* = EXCL PASCAL RAMEN EN DEUREN

Peil= bovenkant afgewerkte vloer

Betreft : AT 86 ST

Getekend : WK

Onderwerp : Deur bi

Datum : 28-07-2023

Onderdeel : Linkerzijdetail

Schaal : 1:2

Vuurijzer 9
5753 SV Deurne
Tel: 0493 31 77 81

ADbi 3

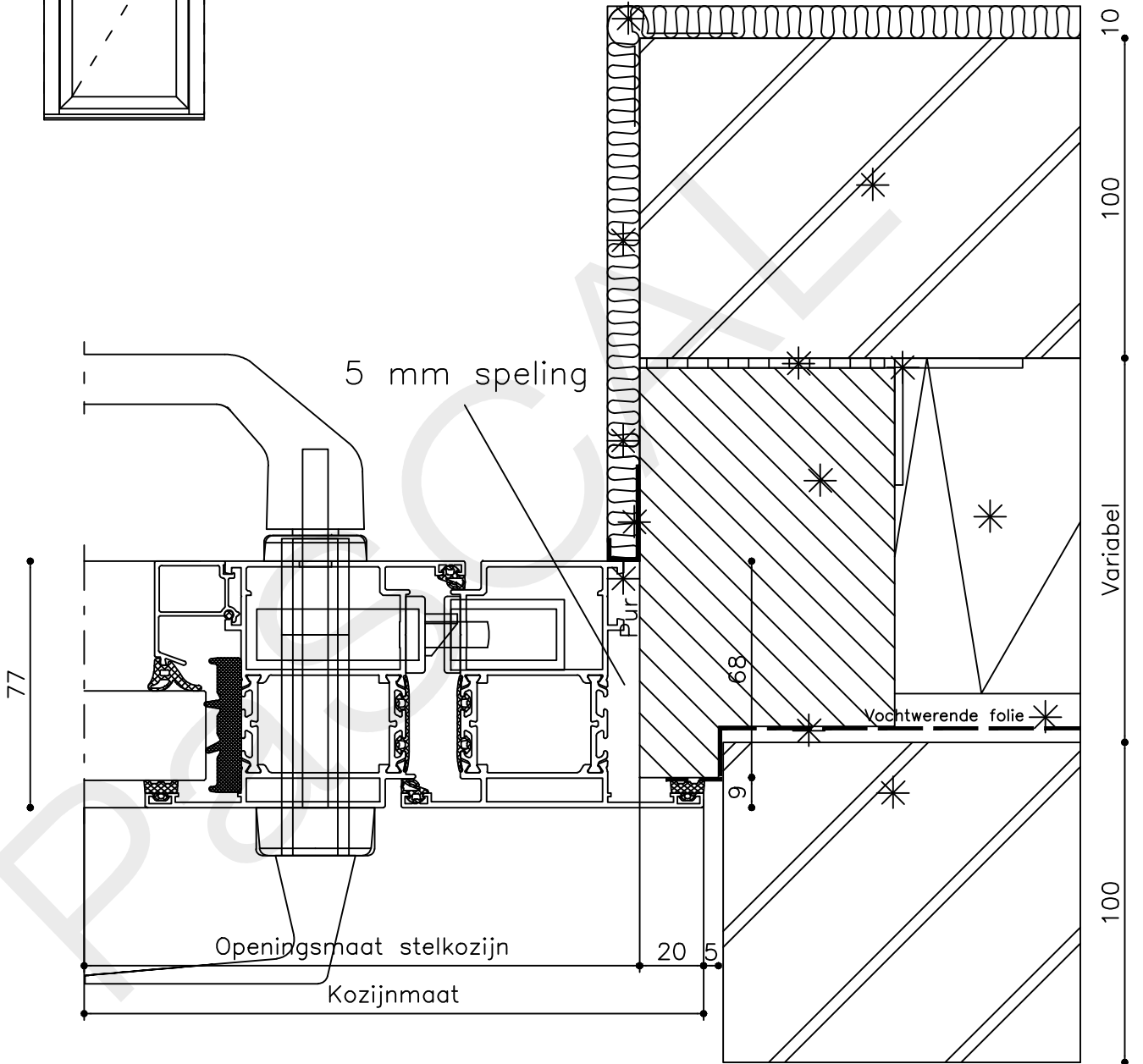
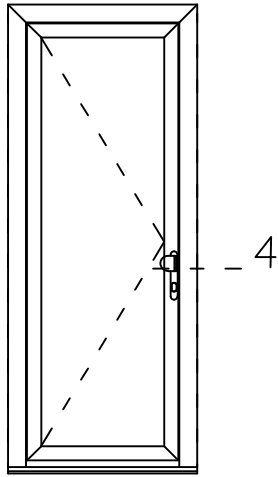

* = EXCL PASCAL RAMEN EN DEUREN

Peil= bovenkant afgewerkte vloer

Betreft : AT 86 ST

Getekend : WK

Onderwerp : Deur bi

Datum : 28-07-2023

Onderdeel : Rechterzijdetail

Schaal : 1:2

Vuurijzer 9
5753 SV Deurne
Tel: 0493 31 77 81

ADbi 4