

5

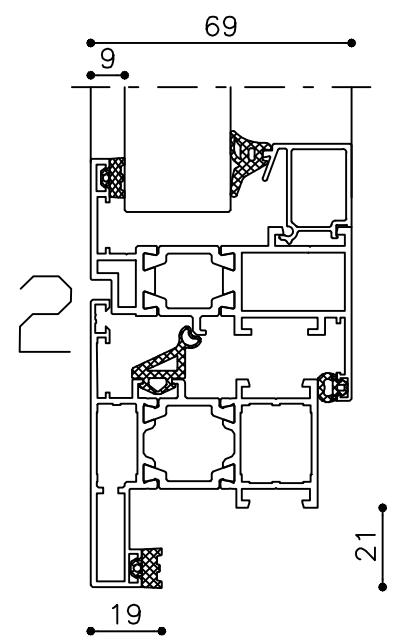

* = EXCL PASCAL RAMEN EN DEUREN

Peil= bovenkant afgewerkte vloer

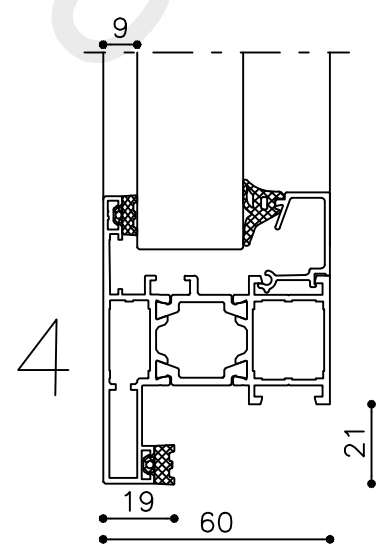

Betreft : AT 60

Onderwerp : Draai val vast raam

Onderdeel : Profielen

Vuurijzer 9

5753 SV Deurne

Tel: 0493 31 77 81

Getekend : LvD

Datum : 08-04-2019

Schaal : 1:2

ADVWR 0

1:1

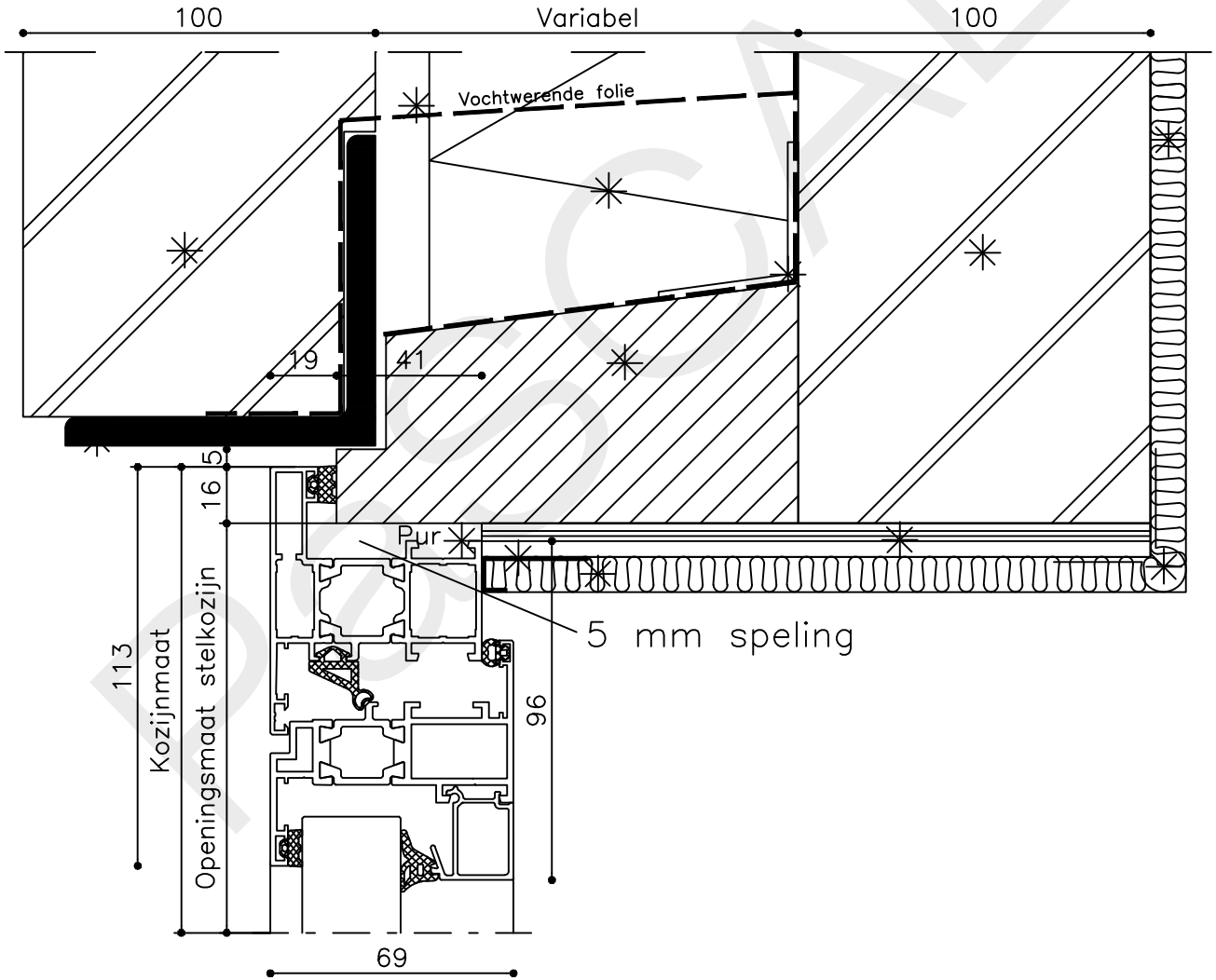
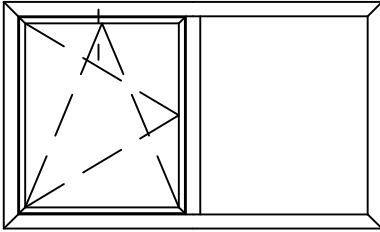

* = EXCL PASCAL RAMEN EN DEUREN

Peil= bovenkant afgewerkte vloer

Betreft : AT 60

Onderwerp : Draai val vast raam

Onderdeel : Bovendetail

Vuurijzer 9

5753 SV Deurne

Tel: 0493 31 77 81

Getekend : LvD

Datum : 08-04-2019

Schaal : 1:2



ADVVR 1

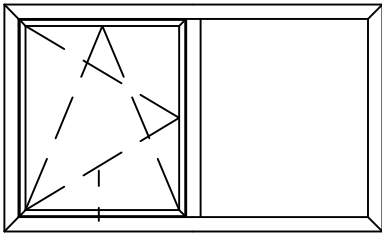

2

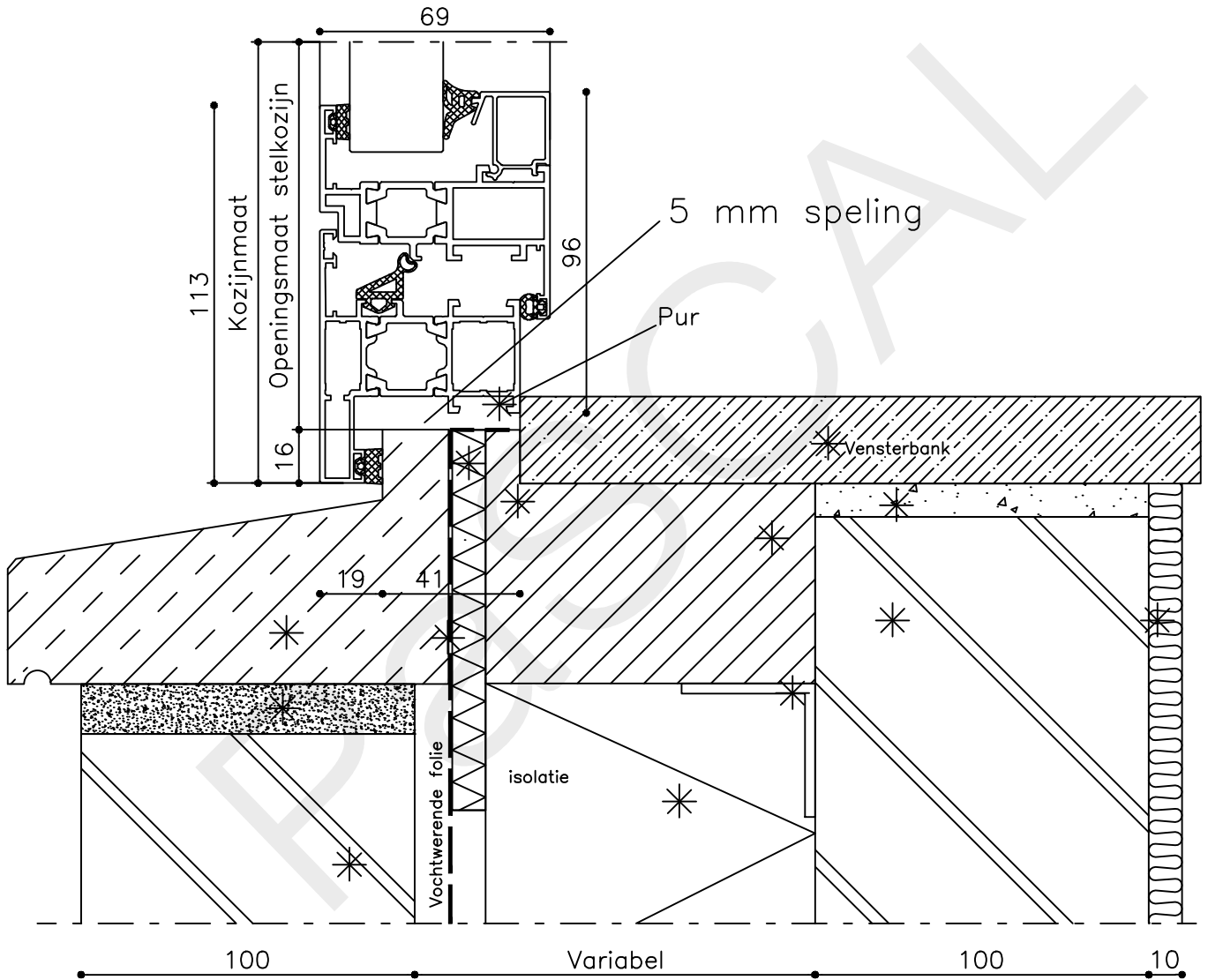

* = EXCL PASCAL RAMEN EN DEUREN

Peil= bovenkant afgewerkte vloer

Betreft : AT 60

Getekend : LvD

Onderwerp : Draai val vast raam

Datum : 08-04-2019

Onderdeel : Onderdetail

Schaal : 1:2

Vuurijzer 9
5753 SV Deurne
Tel: 0493 31 77 81

ADVVR 2

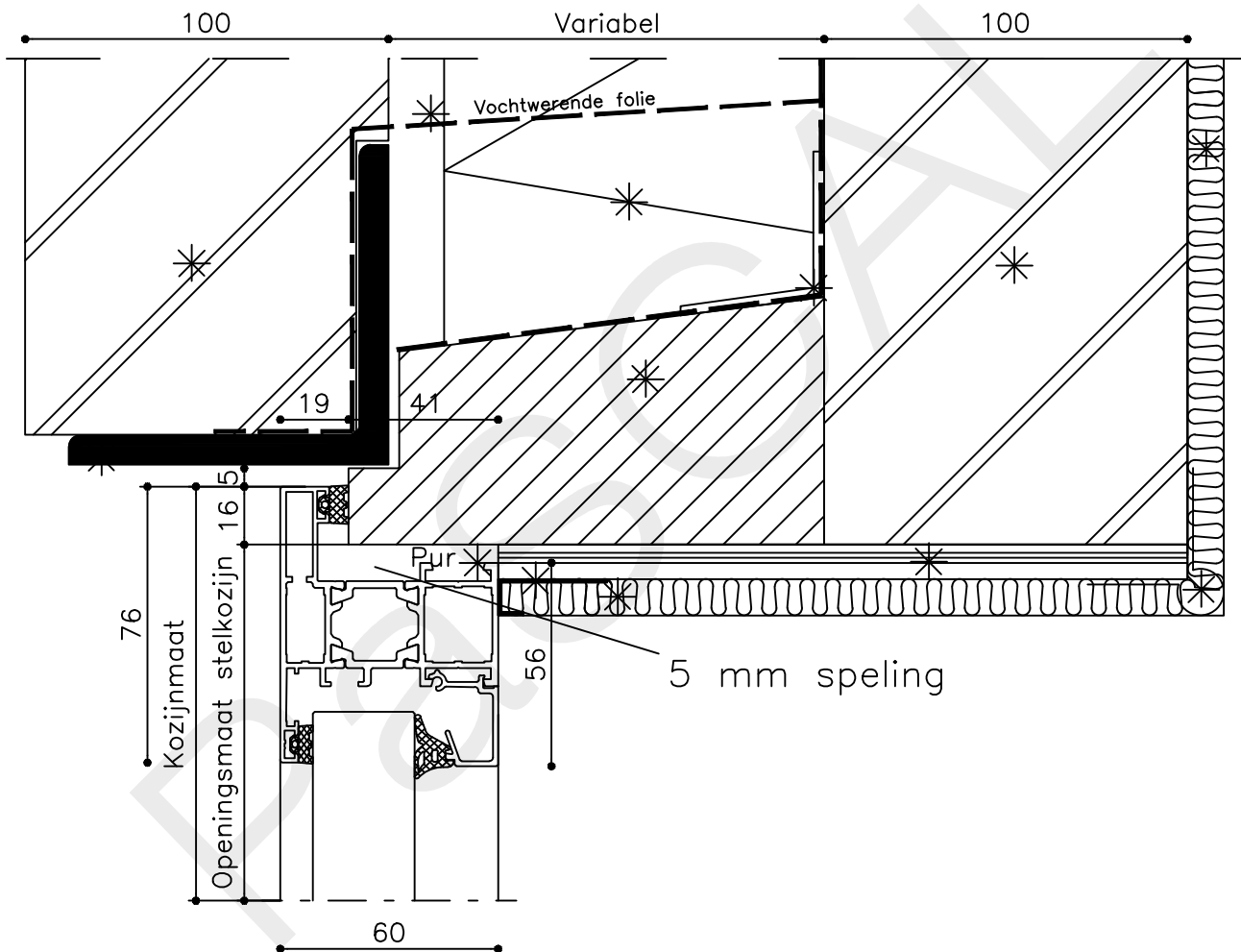
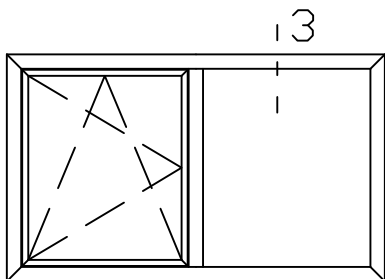

* = EXCL PASCAL RAMEN EN DEUREN

Peil= bovenkant afgewerkte vloer

Betreft : AT 60

Getekend : LvD

Onderwerp : Draai val vast raam

Datum : 08-04-2019

Onderdeel : Bovendetail

Schaal : 1:2

Vuurijzer 9
5753 SV Deurne
Tel: 0493 31 77 81

ADWR 3

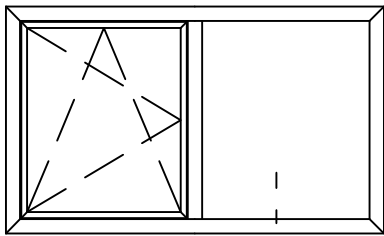

1/4

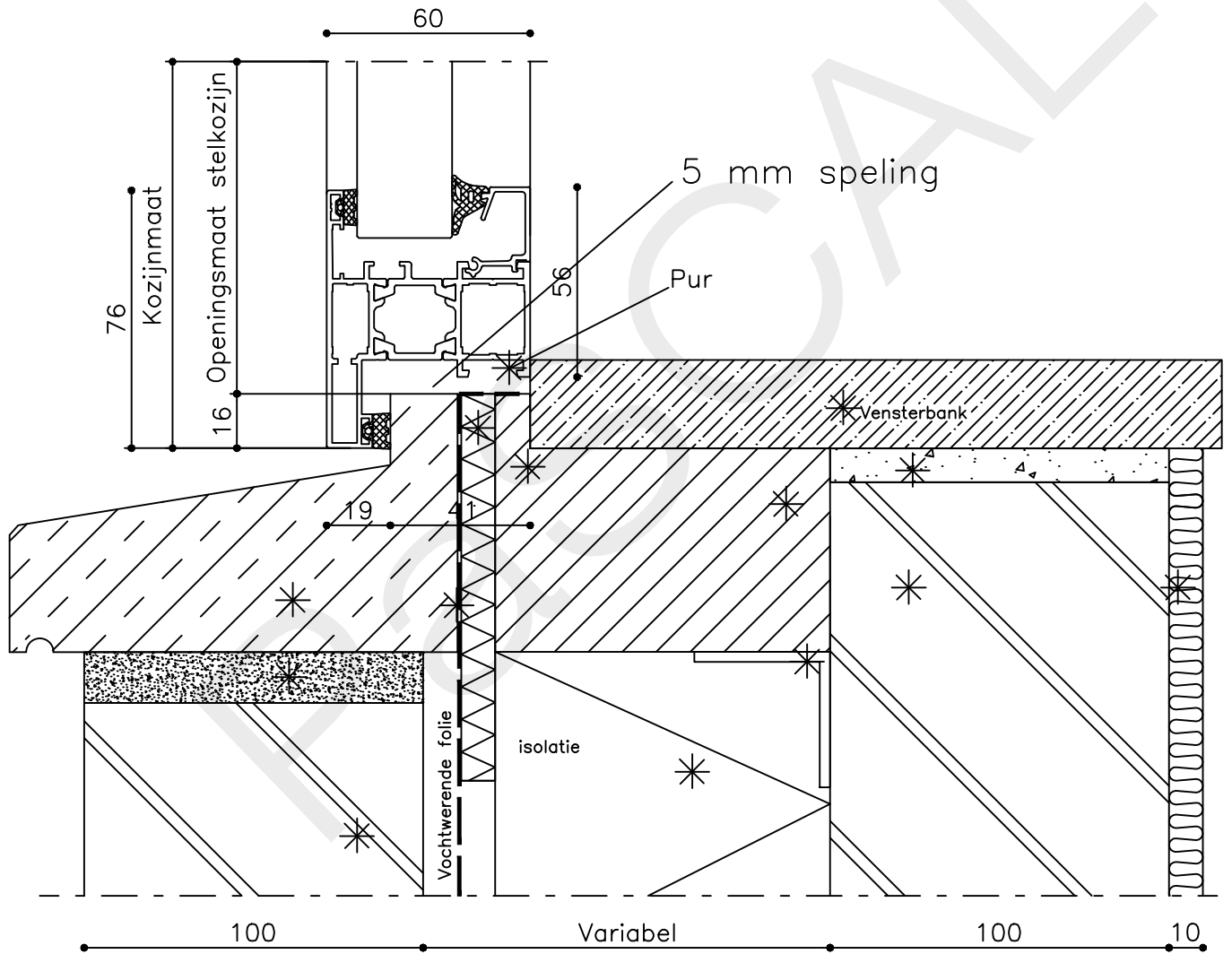

* = EXCL PASCAL RAMEN EN DEUREN

Peil= bovenkant afgewerkte vloer

Betreft : AT 60

Getekend : LvD

Onderwerp : Draai val vast raam

Datum : 08-04-2019

Onderdeel : Onderdetail

Schaal : 1:2

Vuurijzer 9
5753 SV Deurne
Tel: 0493 31 77 81

ADVVR 4



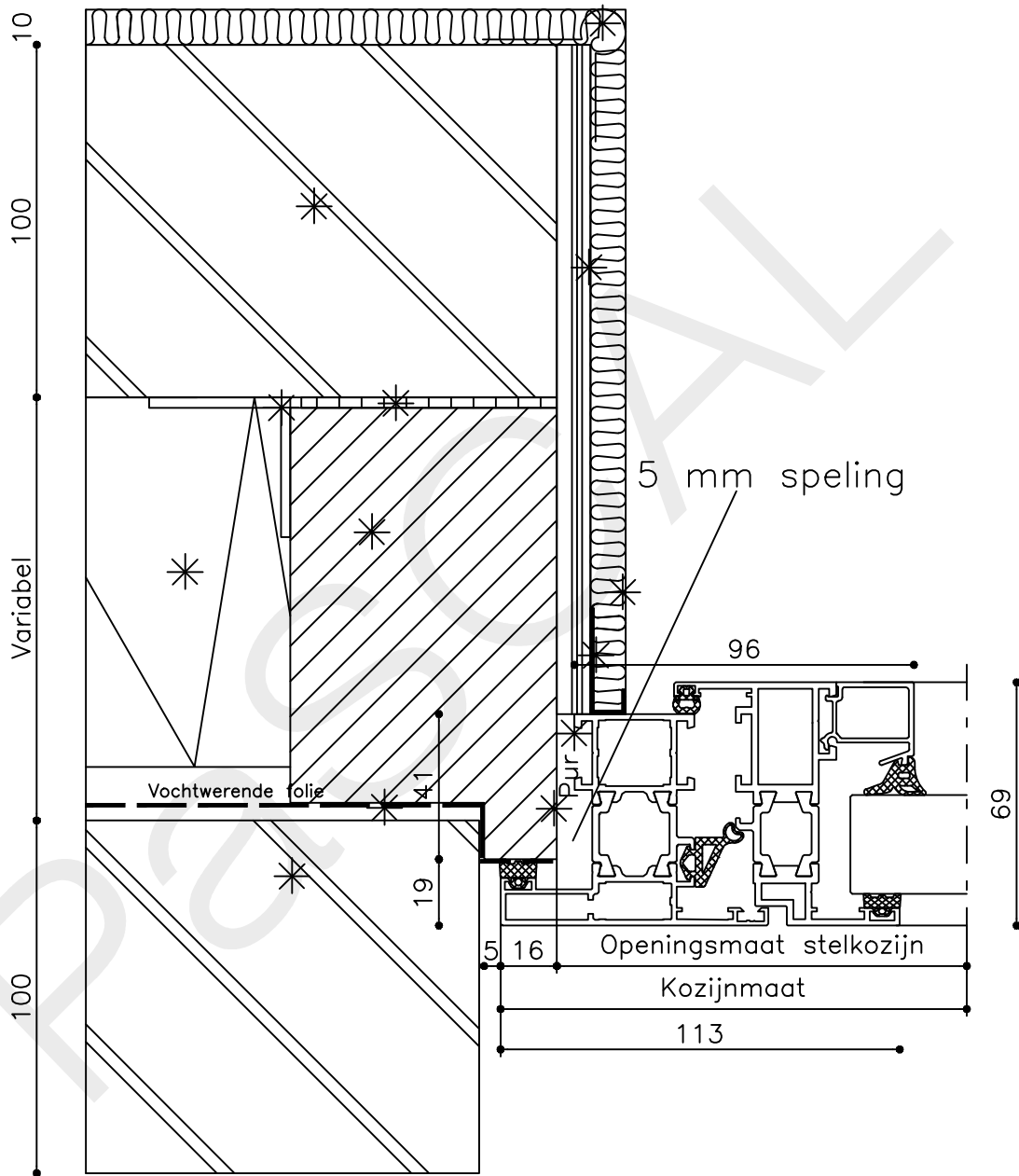
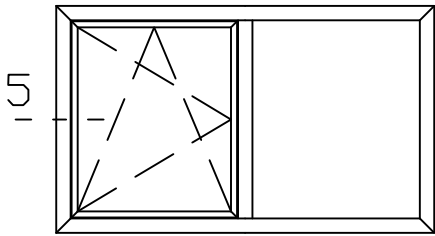

* = EXCL PASCAL RAMEN EN DEUREN

Peil= bovenkant afgewerkte vloer

Betreft : AT 60

Getekend : LvD

Onderwerp : Draai val vast raam

Datum : 08-04-2019

Onderdeel : Linkerzijdetail

Schaal : 1:2

Vuurijzer 9
5753 SV Deurne
Tel: 0493 31 77 81

ADVVR 5



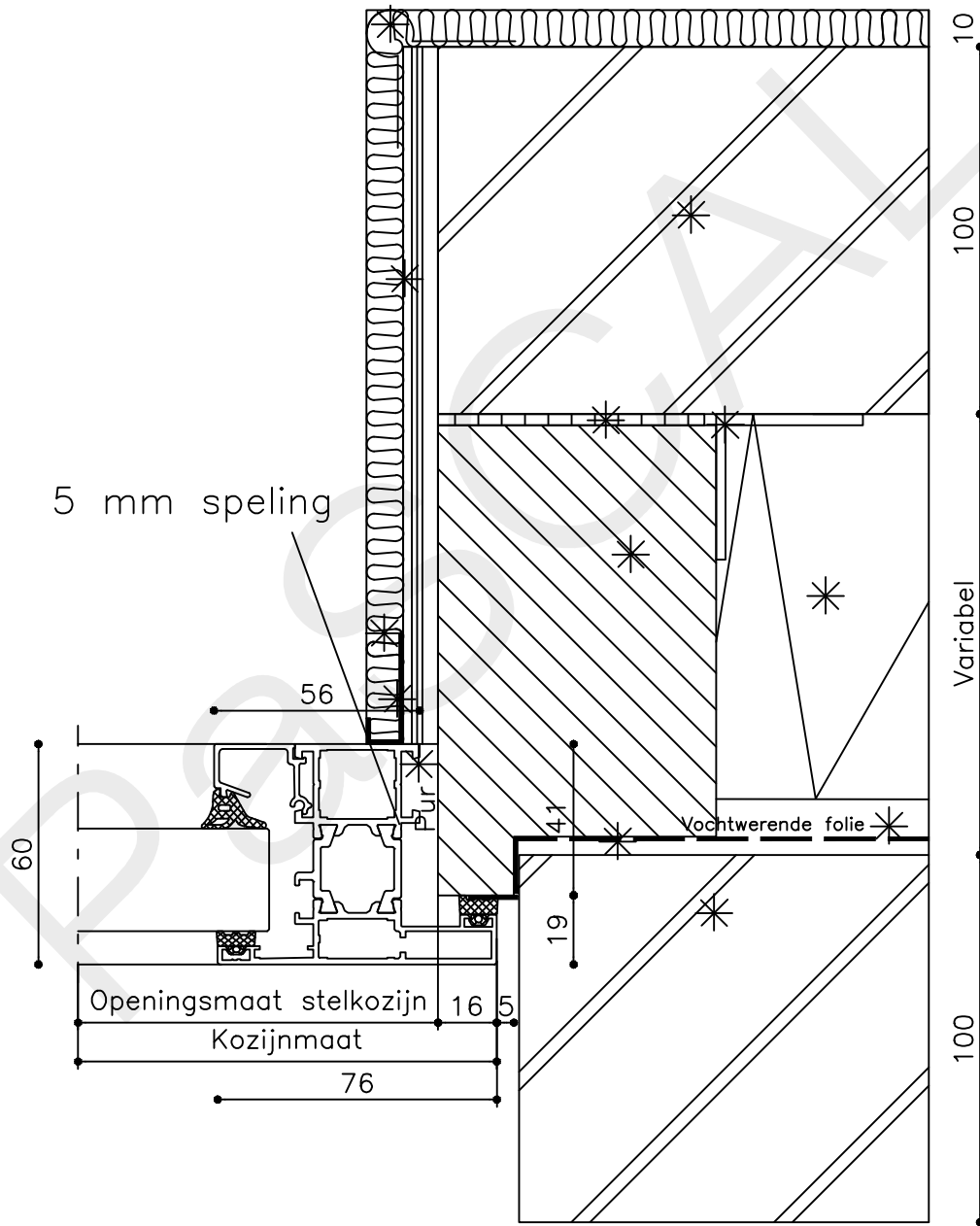
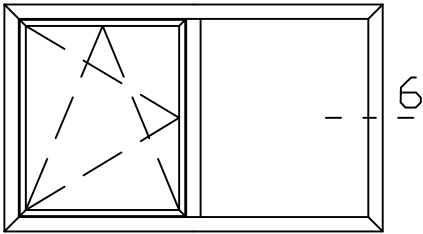

* = EXCL PASCAL RAMEN EN DEUREN

Peil= bovenkant afgewerkte vloer

Betreft : AT 60

Getekend : LvD

Onderwerp : Draai val vast raam

Datum : 08-04-2019

Onderdeel : Rechterzijdetail

Schaal : 1:2

Vuurijzer 9
5753 SV Deurne
Tel: 0493 31 77 81

ADWR 6

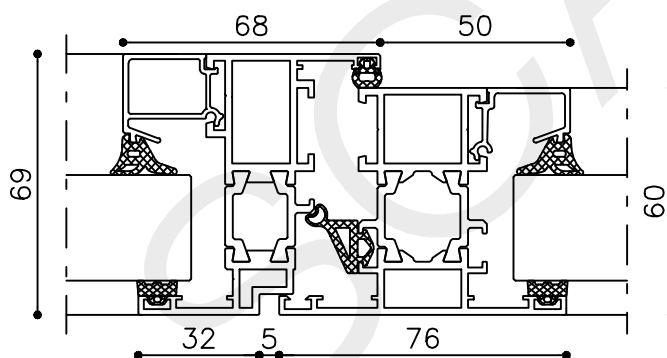
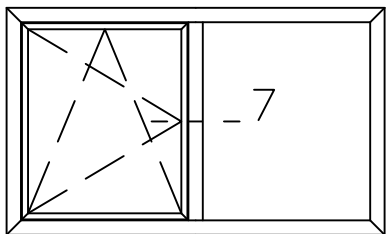

* = EXCL PASCAL RAMEN EN DEUREN

Peil= bovenkant afgewerkte vloer

Betreft : AT 60

Getekend : LvD

Onderwerp : Draai val vast raam

Datum : 08-04-2019

Onderdeel : Tussenstijl

Schaal : 1:2

Vuurijzer 9
5753 SV Deurne
Tel: 0493 31 77 81

ADWR 7

